

TCS-173-M-Z-11060

MOUNT IN KISTLER 6051A0.5 PORT

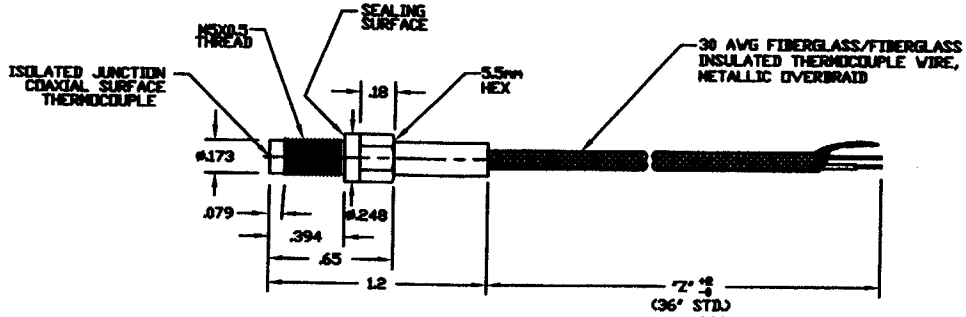

TCS-173-MU-Z-11079

TRIAxIAL ISOLATED JUNCTION, MOUNT IN KISTLER 6051A0.5 PORT

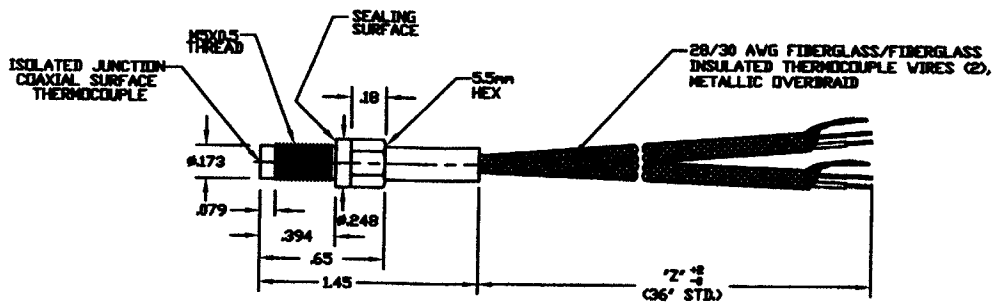

TCS-173-MU(MN-X)-Z-11080

TRIAxIAL ISOLATED JUNCTION, BACKSIDE THERMOCOUPLE, MOUNT IN KISTLER 6051A0.5 PORT

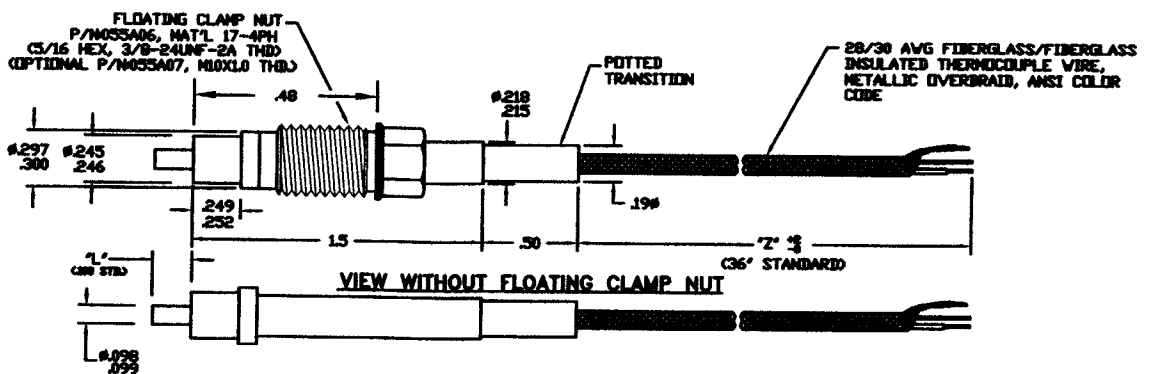

TCS-099-M-L-Z-11094

MOUNT IN KISTLER 6125A PORT

*M*	THERMOCOUPLE MATERIAL
K	CHROMEL/ALUMEL
T	COPPER/CONSTANTAN
J	IRON/CONSTANTAN
E	CHROMEL/CONSTANTAN
S	Pt100Rh/PtE (#.015 or #.031)
FcNi	IRON/NICKEL

(OTHERS AVAILABLE)



有限会社テクノオフィス

〒225-0011  
 神奈川県横浜市青葉区あざみ野3-20-8-B  
 TEL.045-901-9861 FAX.045-901-9522  
 URL: <http://www.techno-office.com>

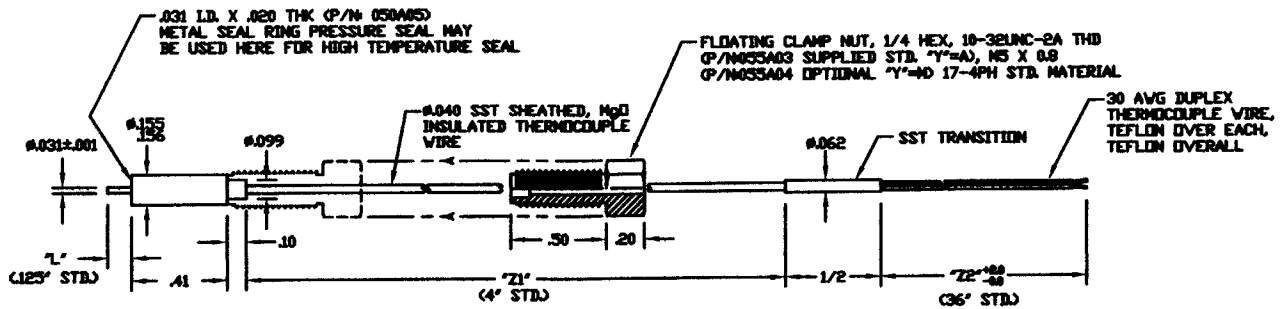

TCS-031-M-L-Y-Z1-Z2-11041

MOUNT PER KISTLER 6051A0.5

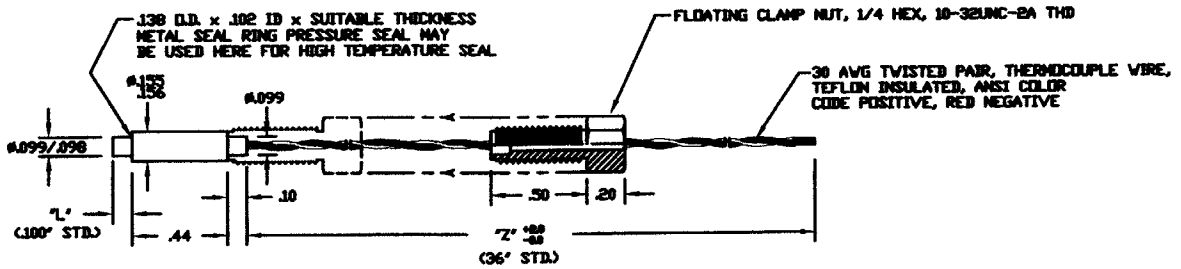

TCS-099-M-L-Y-Z-11044A

MOUNT PER KISTLER 6051A0.5

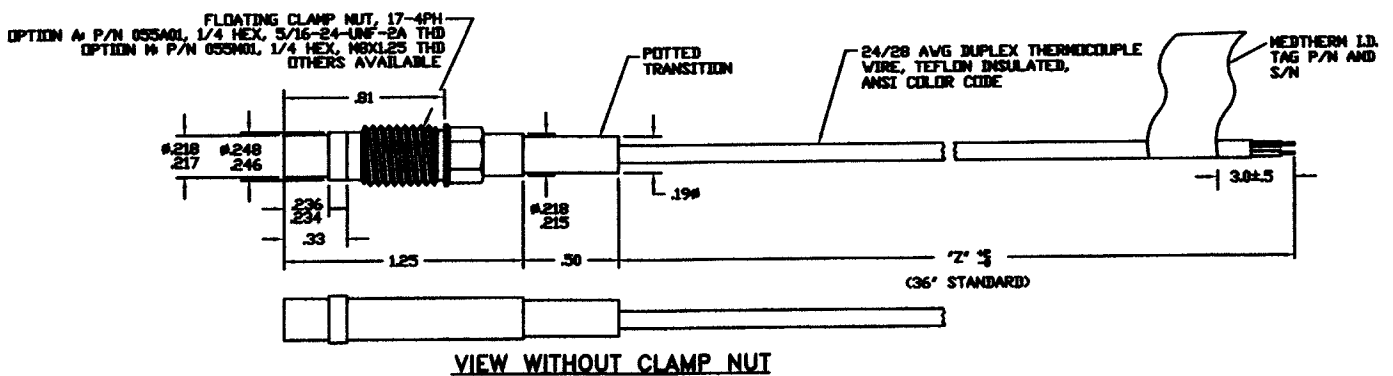

TCS-218-M-Y-Z-11045A

MOUNT IN KISTLER OR PCB PORT

P/N TCS-218-M-Z-11046 DOES NOT INCLUDE A CLAMP NUT

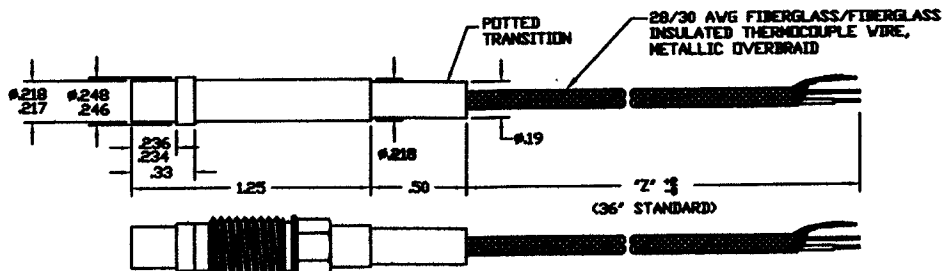

ALSO AVAILABLE WITH CHOICE OF CLAMP NUT AS P/N TCS-218-M-Y-Z-11045

TCS-218-M-Z-11046

MOUNT PER KISTLER 6125A

TW	THERMOCOUPLE MATERIAL
K	CHROMEL/ALUMEL
T	COPPER/CONSTANTAN
J	IRON/CONSTANTAN
E	CHROMEL/CONSTANTAN
S	P-6104h/Pt (#015 or #031)
FeNi	IRON/NICKEL

(OTHERS AVAILABLE)



有限会社テクノオフィス

〒225-0011  
 神奈川県横浜市青葉区あざみ野3-20-8-B  
 TEL.045-901-9861 FAX.045-901-9522  
 URL: <http://www.techno-office.com>

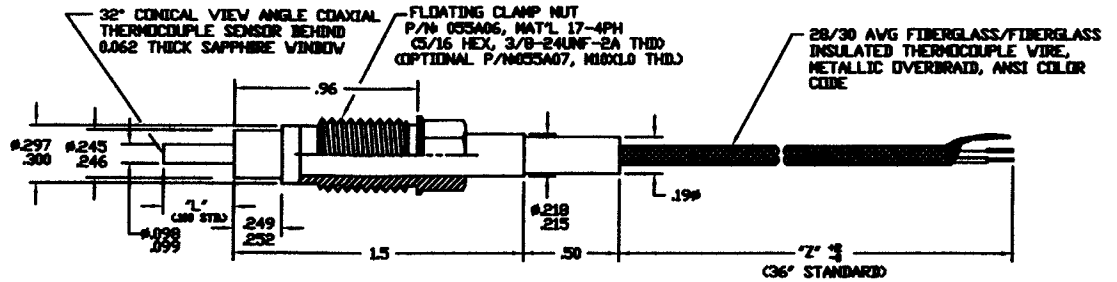

TCSR-099-M-L-Z-11095

MOUNT IN KISTLER OR PCB PORT

P/N TCS-244-M-Z-11338 DOES NOT INCLUDE A CLAMP NUT

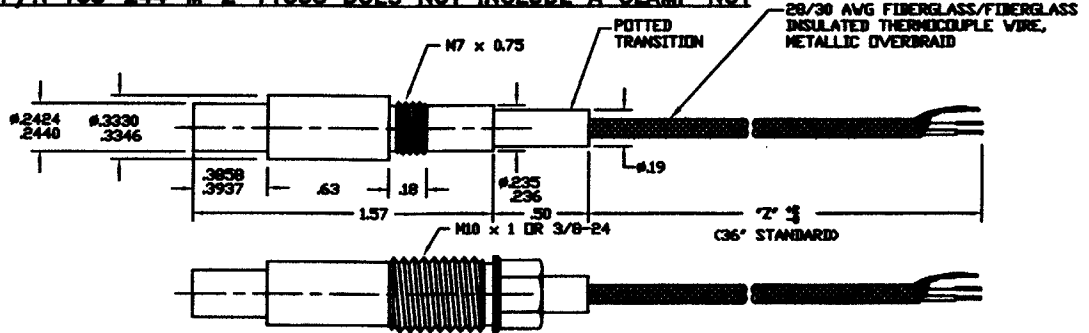

ALSO AVAILABLE WITH CHOICE OF CLAMP NUT AS P/N TCS-244-M-Y-Z-11337

TCS-244-M-Z-11338

MOUNT IN KISTLER OR PCB PORT

P/N TCS-244-MU-Z-11340 DOES NOT INCLUDE A CLAMP NUT

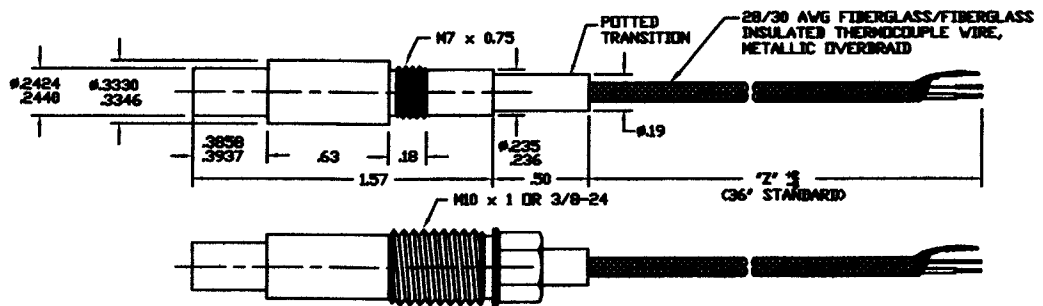

ALSO AVAILABLE WITH CHOICE OF CLAMP NUT AS P/N TCS-244-MU-Y-Z-11339

TCS-244-MU-Z-11340

TRIAxIAL ISOLATED JUNCTION,  
MOUNT IN KISTLER OR PCB PORT

P/N TCS-244-MU-L-Z-11340A DOES NOT INCLUDE A CLAMP NUT

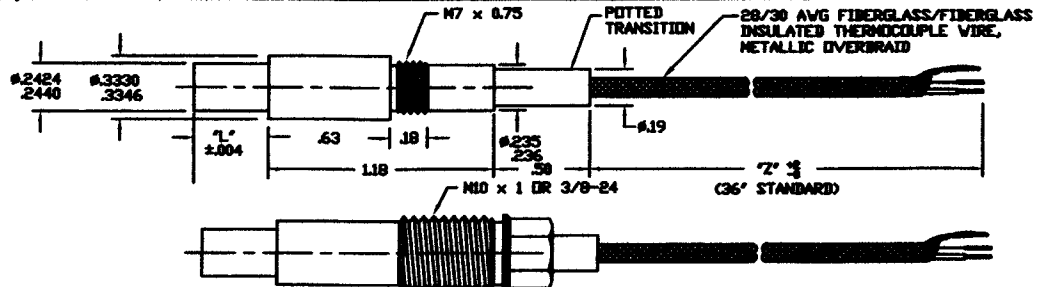

ALSO AVAILABLE WITH CHOICE OF CLAMP NUT AS P/N TCS-244-MU-L-Y-Z-11339A

TCS-244-MU-L-Z-11340A

MOUNT IN KISTLER 6125A OR PCB PORT

"M"	THERMOCOUPLE MATERIAL
K	CHROMEL/ALUMEL
T	COPPER/CONSTANTAN
J	IRON/CONSTANTAN
E	CHROMEL/CONSTANTAN
S	Pt10Rh/Pt (#.015 or #.031)
F-NI	IRON/NICKEL

(OTHERS AVAILABLE)



有限会社テクノオフィス

〒225-0011

神奈川県横浜市青葉区あざみ野3-20-8-B

TEL.045-901-9861 FAX.045-901-9522

URL: <http://www.techno-office.com>

ALUMINUM ALLOY HOUSING

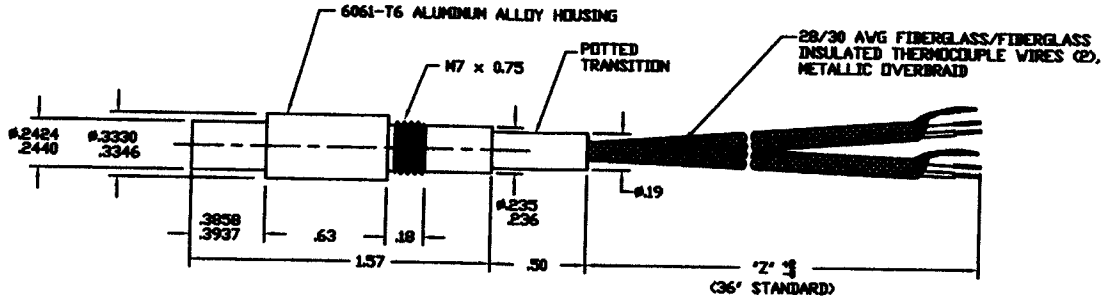

TCS-244-AL-JU(JU-.156)-Z-11443

MOUNT IN KISTLER OR PCB PORT

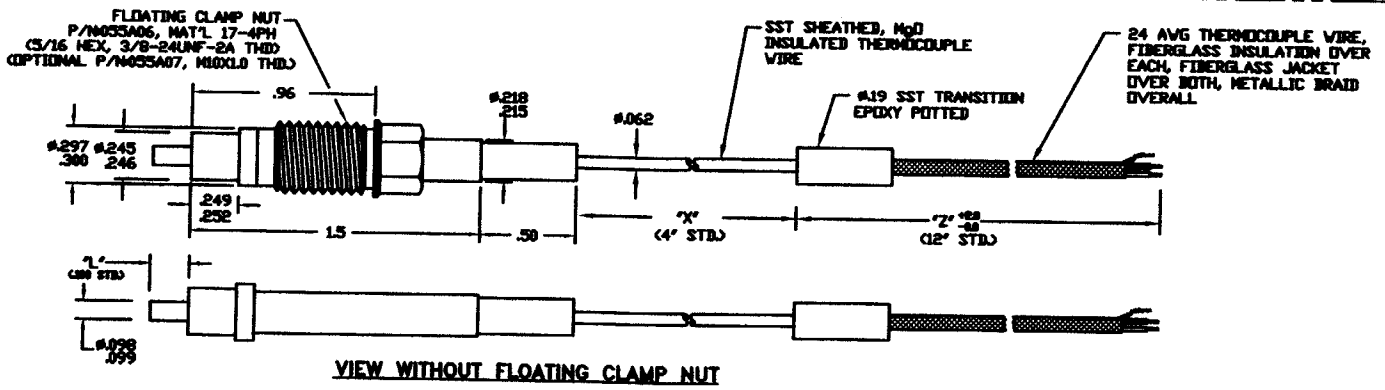

TCS-099-M-L-X-Z-11459

MOUNT IN KISTLER OR PCB PORT

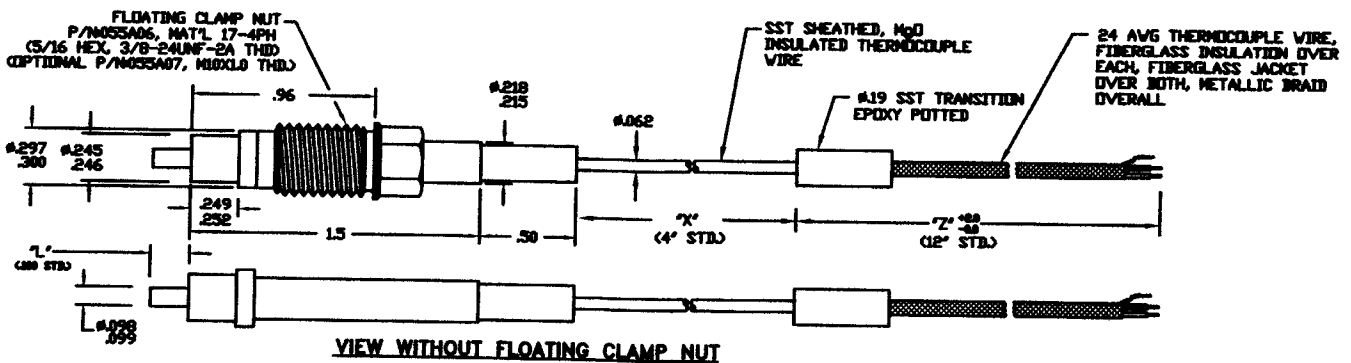

TCS-099-MU-L-X-Z-11460

TRIAxIAL ISOLATED JUNCTION,  
MOUNT IN KISTLER OR PCB PORT

"M"	THERMOCOUPLE MATERIAL
K	CHROMEL/ALUMEL
T	COPPER/CONSTANTAN
J	IRON/CONSTANTAN
E	CHROMEL/CONSTANTAN
S	Pt100h/Pt (#.015 or #.030)
FeNi	IRON/NICKEL

(OTHERS AVAILABLE)



有限会社テクノオフィス

〒225-0011  
神奈川県横浜市青葉区あざみ野3-20-8-B  
TEL.045-901-9861 FAX.045-901-9522  
URL: <http://www.techno-office.com>